

# VMP

## DEEP CYCLE BATTERY

### VPD12-120 12V120Ah

#### ● Specifications

Nominal Voltage		12V
Rated capacity (10 hour rate)		120Ah
Dimensions	Length	407mm
	Width	173mm
	Height	208mm
	Total Height	233mm
Approx. Weight		32.6kg

#### ● Outer dimensions (mm)

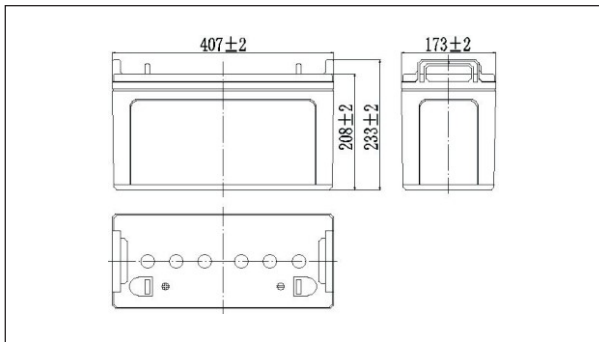

#### ● Terminal Type (mm)

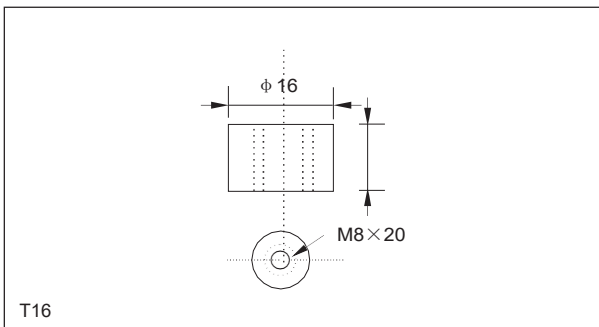

#### ● Characteristics

Capacity (25°C)	10HR(10.8V)	120Ah
	3HR(10.8V)	90Ah
	1HR(10.5V)	66Ah
Terminal type		T16
Internal resistance (Fully charged, 25°C)		Approx. 4m Ω
Capacity affected by temperature (10HR)	40°C	102%
	25°C	100%
	0°C	85%
	-15°C	65%
Self-discharge (25°C)	3 months	Remaining Capacity: 91%
	6 months	Remaining Capacity: 82%
	12 months	Remaining Capacity: 65%
Nominal operating temperature		25°C ± 3°C
Operating temperature range	Discharge	-15°C ~ 50°C
	Charge	-10°C ~ 50°C
	Storage	-20°C ~ 50°C
Float charging voltage(25°C)		13.50 to 13.80V Temperature compensation: -18mV/°C
Cyclic charging voltage(25°C)		14.50 to 15.00V Temperature compensation: -30mV/°C
Maximum charging current		36A
Maximum discharge current		950A(5 sec.)
Designed floating life(20°C)		10years

#### ● Construction

Component	Positive plate	Negative plate	Container	Cover	Separator	Electrolyte	Safety valve	Terminal
Raw material	Lead dioxide	Lead	ABS	ABS	AGM	Sulfuric acid	Rubber	Copper

#### ● Constant Current Discharge Characteristics Unit:A(25°C)

F.V/Time	10min	15min	30min	60min	2h	3h	4h	5h	8h	10h	20h
9.60V	262	202	121	74.2	43.8	31.6	25.2	21.5	14.8	12.2	6.47
9.90V	254	197	118	73.0	43.6	31.4	25.1	21.4	14.7	12.2	6.46
10.2V	243	190	115	71.2	43.2	31.2	24.9	21.3	14.6	12.2	6.44
10.5V	233	183	112	69.0	42.6	31.0	24.7	21.1	14.5	12.1	6.40
10.8V	220	173	108	66.7	41.5	30.0	24.0	20.5	14.1	12.0	6.36

#### ● Constant Power Discharge Characteristics Unit:W(25°C)

F.V/Time	10min	15min	30min	60min	2h	3h	4h	5h	8h	10h	20h
9.60V	2825	2214	1353	845	508	371	297	255	176	146	77.7
9.90V	2741	2160	1326	833	505	369	295	253	175	146	77.5
10.2V	2628	2081	1285	812	500	367	293	251	174	145	77.3
10.5V	2514	2010	1254	786	493	364	291	250	172	144	76.9
10.8V	2373	1904	1208	761	408	353	282	242	167	143	76.3

Note: The above characteristics data can be obtained within three charge or discharge cycles.

# NP12-120Ah 12V120Ah



## Discharge characteristics(25°C)

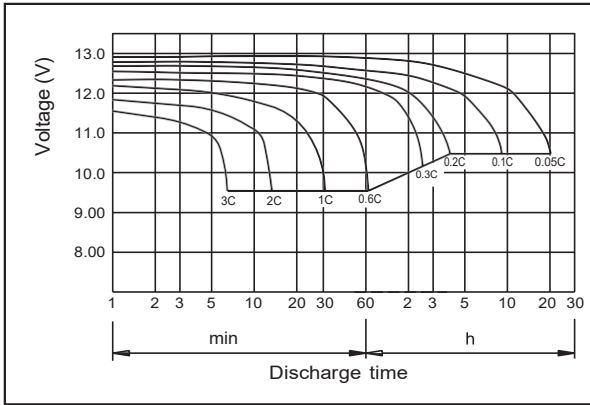

## Charging characteristics (25°C)

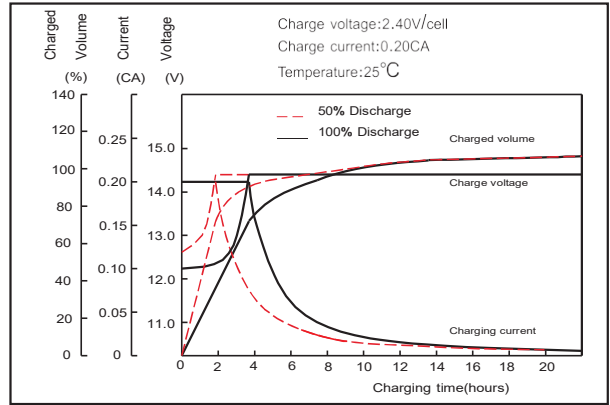

## Temperature effects on Capacity

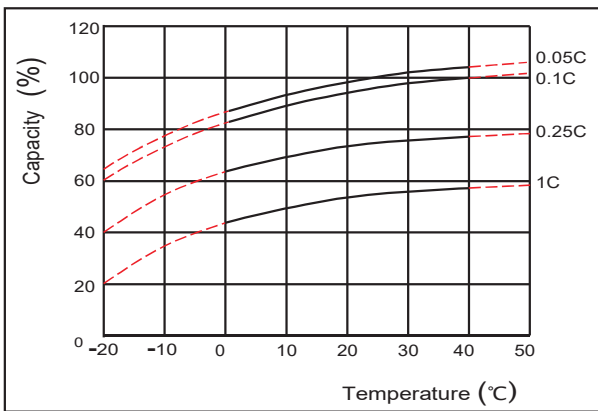

## Self-discharge characteristics

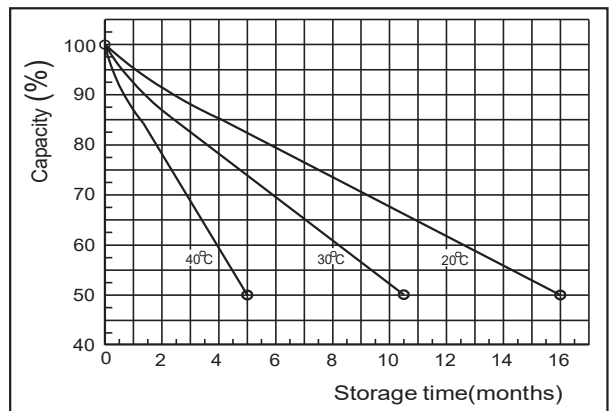

## Floating life on Temperature

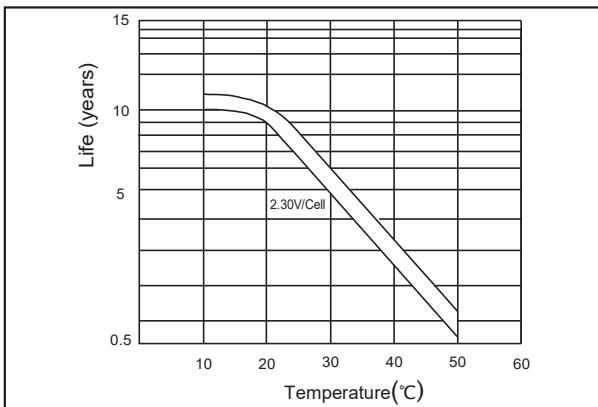

## Cycle life on D.O.D (25°C)

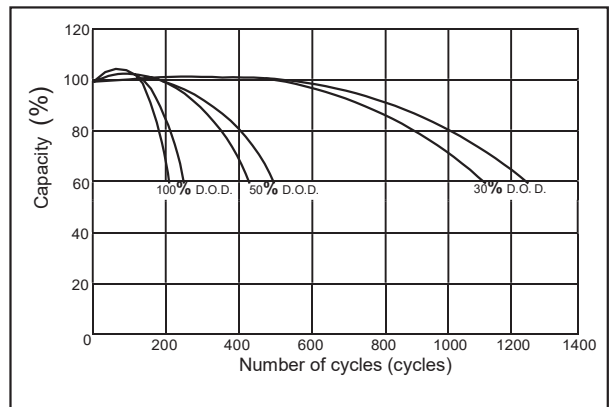

## The relationship for OCV and Capacity (25°C)

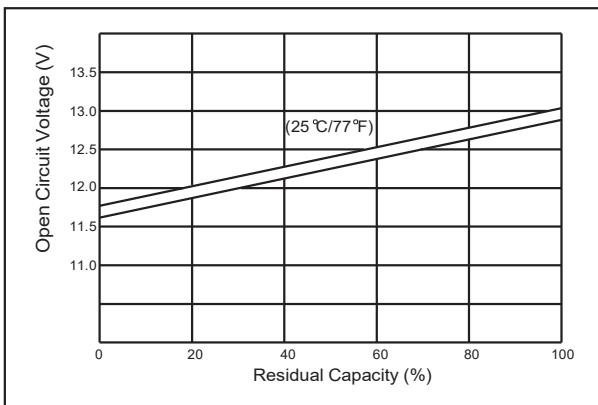

## The relationship for Charging voltage and Temperature

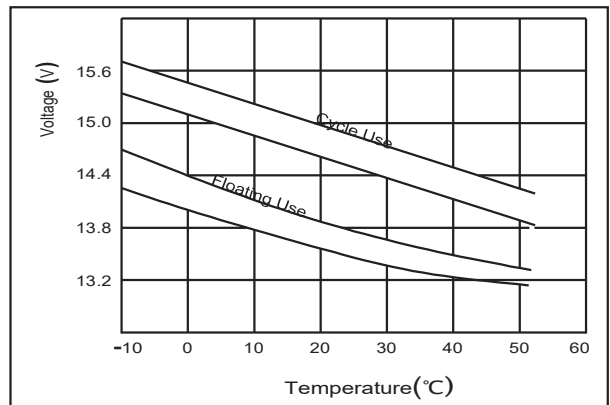

MH47211